



PEZZI DI RICAMBIO TESTE DI CUCITURA E ALIMENTATORI

PUNTO DA 10 mm.

C. INA NKI 20/20
064120008
064120007
075152
RG. Ø 10,5
DB 10 M

C. INA NKI 9/12
064120002
064/8:44..
076065

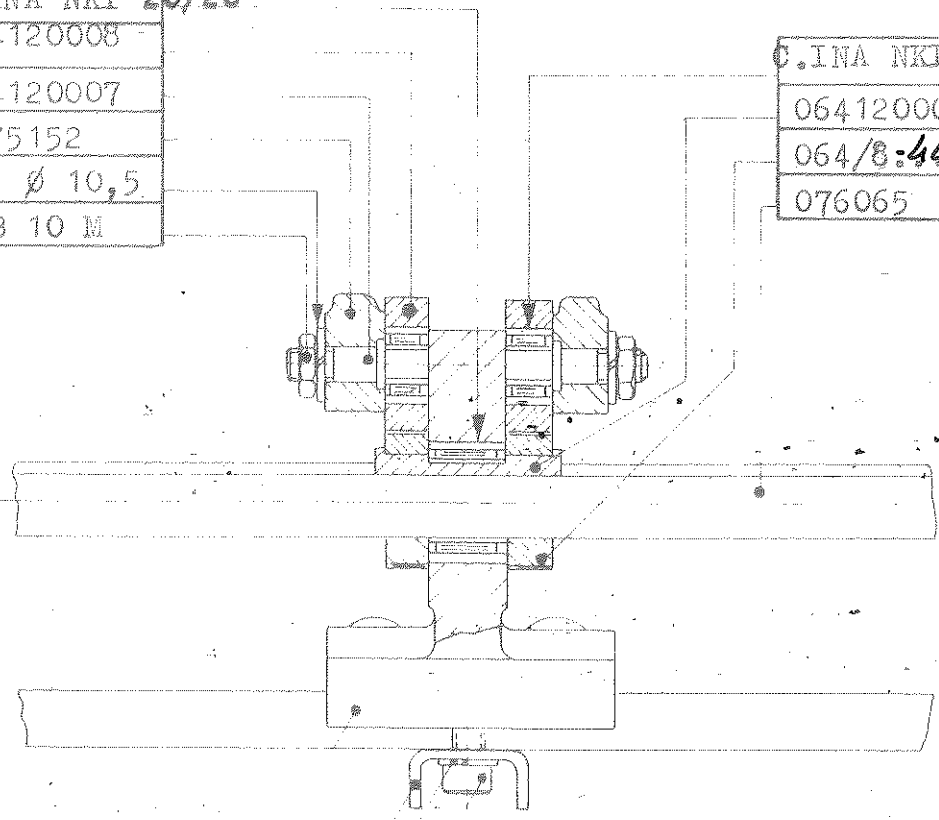

075151
075154
RG Ø 8,5
VCE 8Mx25
125/4.10.12
64/3.10.12
67/86 S
C7511
VCE 6Mx10

064100005

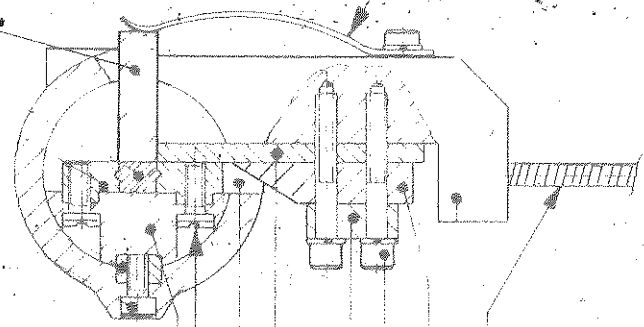

064120021
125270
072205
VCE 6Mx30
072213
072212
76/1.10.12.44
075115
075101



PEZZI DI RICAMBIO LEVE COMANDO TESTE

075 122
075 120
075 118
075 113
RG 12,5 I
VCE 12H,40

VCE12H,100
DE 12 H
075 124
075 108-A
IC 4
075 104
GRUNZIONE
OS 1"-1/4"

075 119
075 121

CO Ø30.22
BRA MB-10-
IO-DU

075102
075101
IC 8
075 103
075 123

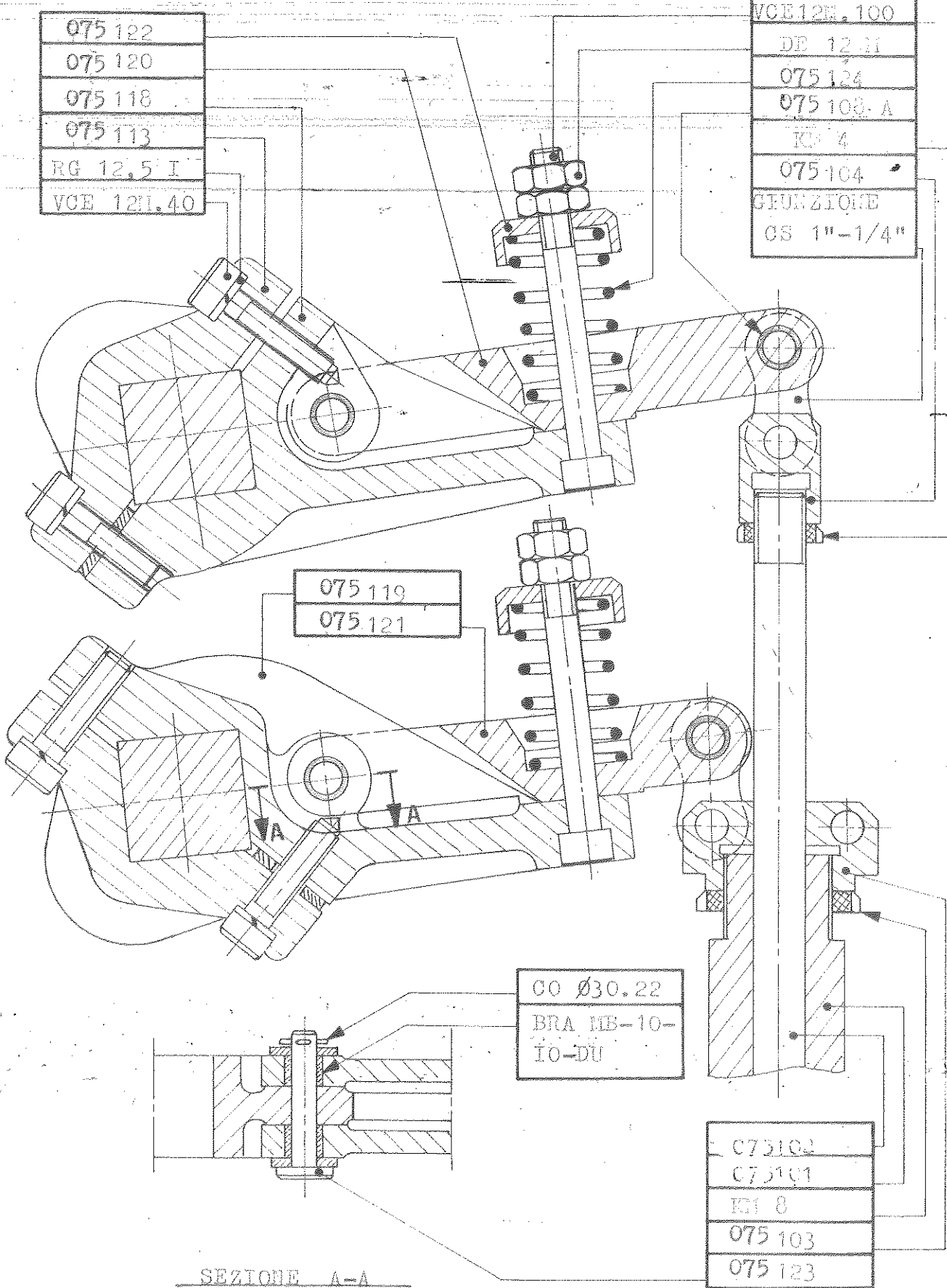

SEZIONE A-A



PEZZI DI RICAMBIO ALIMENTATORE FILO

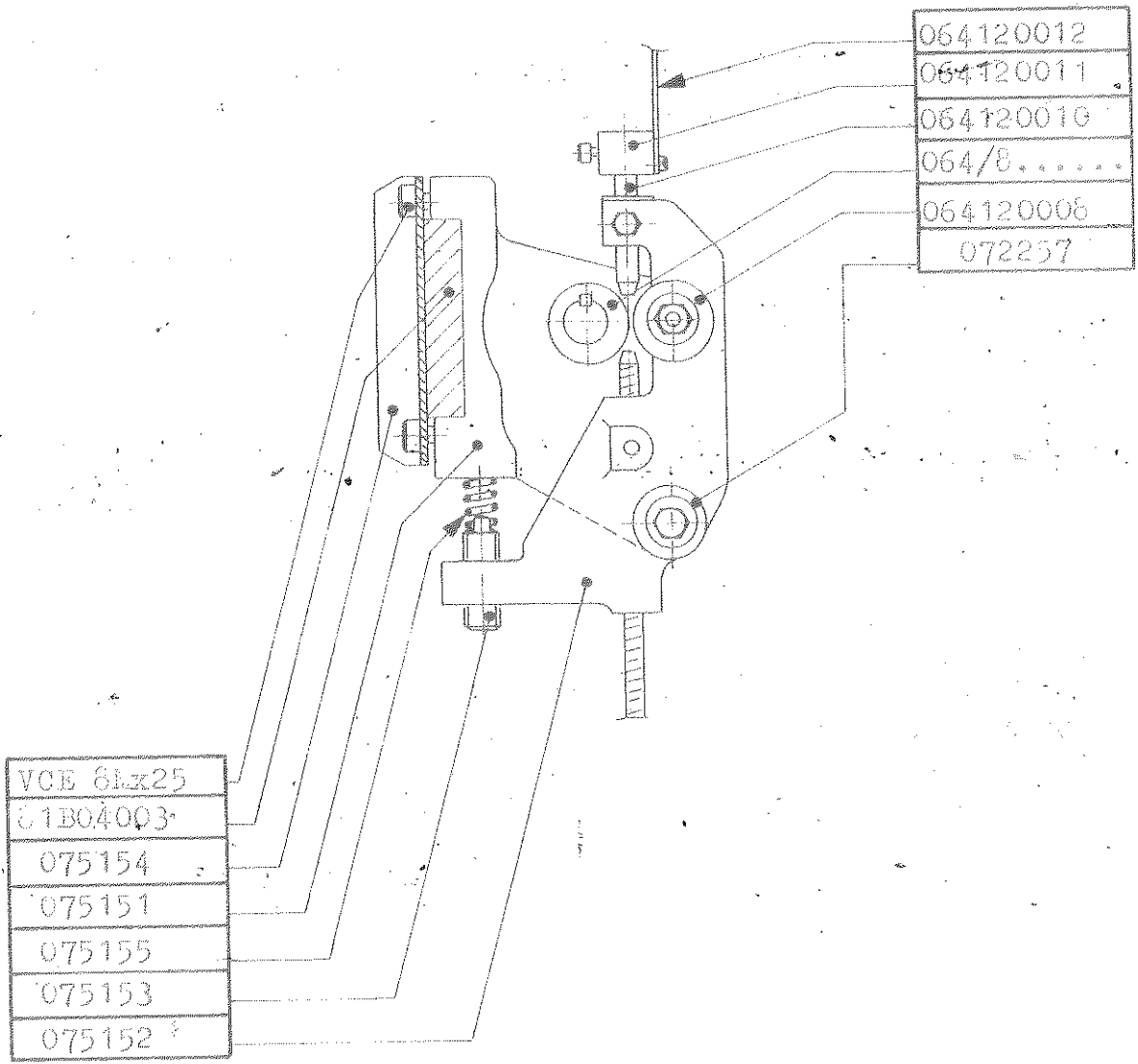



PEZZI DI RICAMBIO COMANDO CARRELLO

V.C.F. 8X20

125013

C. 6206-2RS

125010

CH. 8.7.35

125012

V.C.F. 6X15

V.C.F. 10X25

125011

riduttore
tipo vf62/fc
rapp; 1/24

125021

CH. 8.7.50

CD. 1/2"

CH. 10.8.30

125247

V.T.F. 10X25

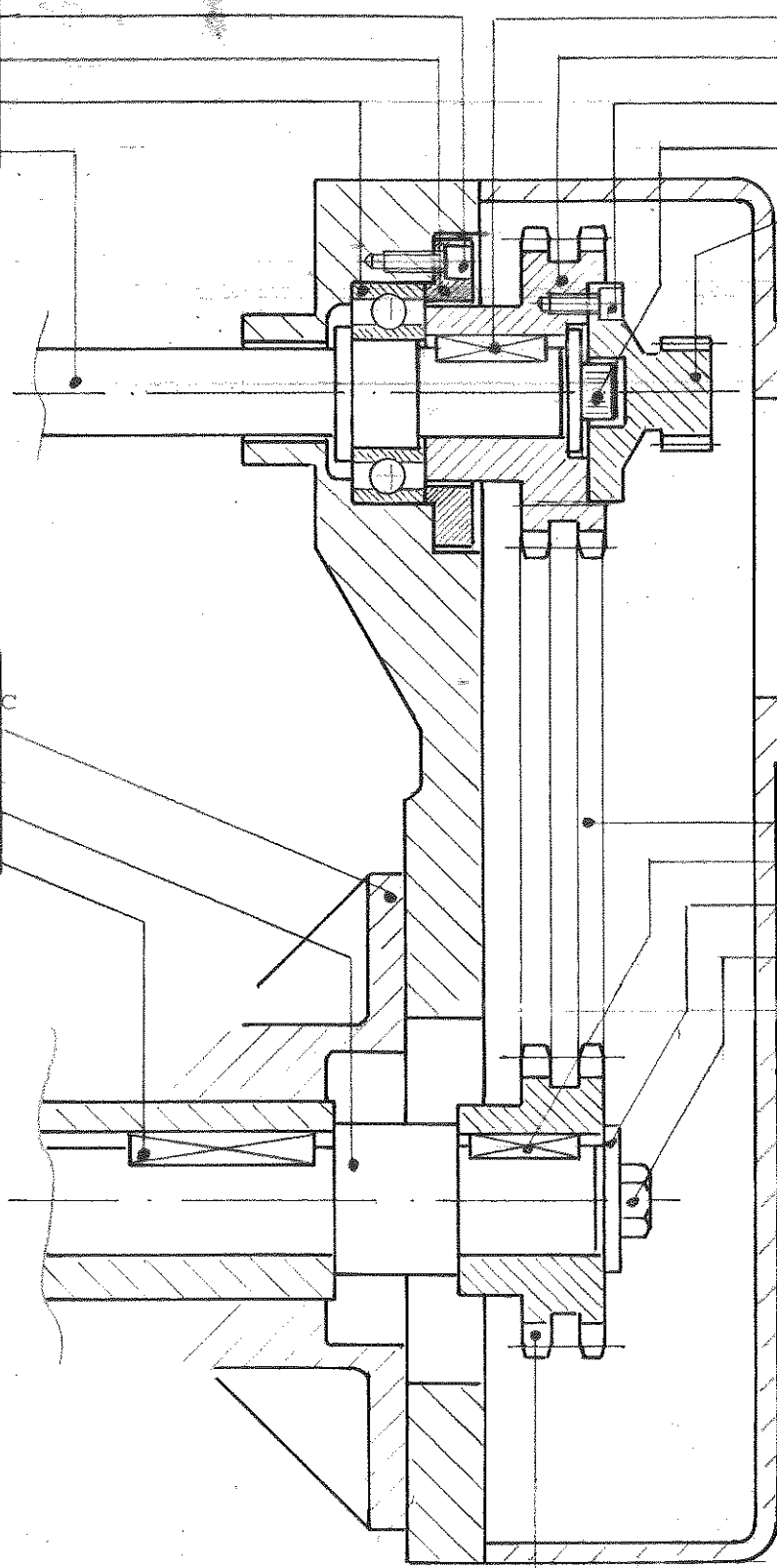

velocità catena 12;5 m.1" dis. 125020 Z=18

Velocità catena 9;7m;/1" dis. 125020 Z=14

PEZZI DI RICAMBIO PROGRAMMATORE GENERALE

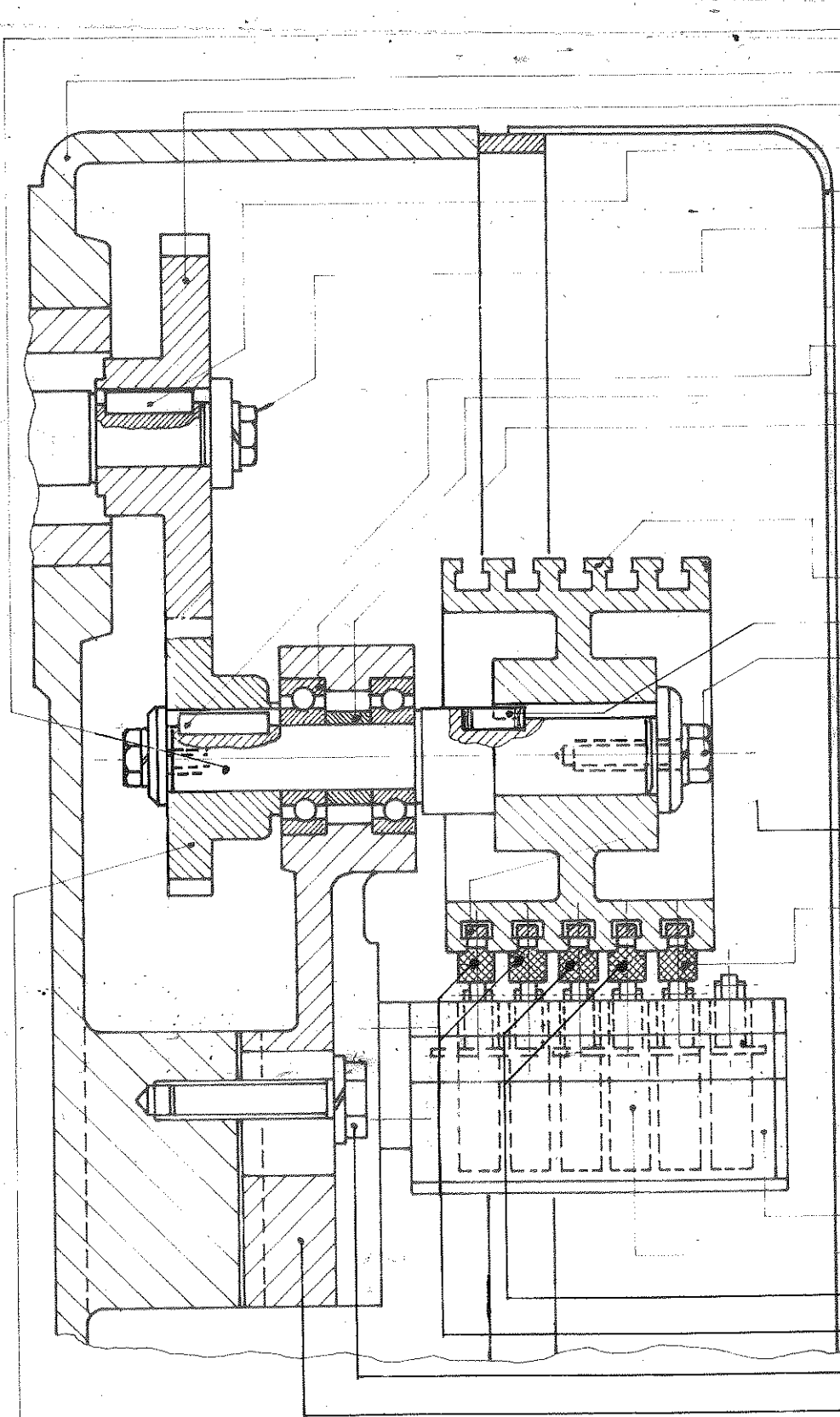

125306
126155
126011
CH 6x6x30
126156
VTE 8x20

CH 6x6x30
C.6204-2 RS
127035

125307
CH 8x7x20
VTE 10x30

125229

127157

GF ELAN
SRA 16.06.R
FC SEA 23
125232
127157
VTE 14x50
127030

PASSO 635 mm. ingran. a Dis.125023B N° 5 passi

PASSO 793,5 mm. ingran. a Dis.125023A N° 4 passi



PEZZI DI RICAMBIO CARICATORE FIANCATE

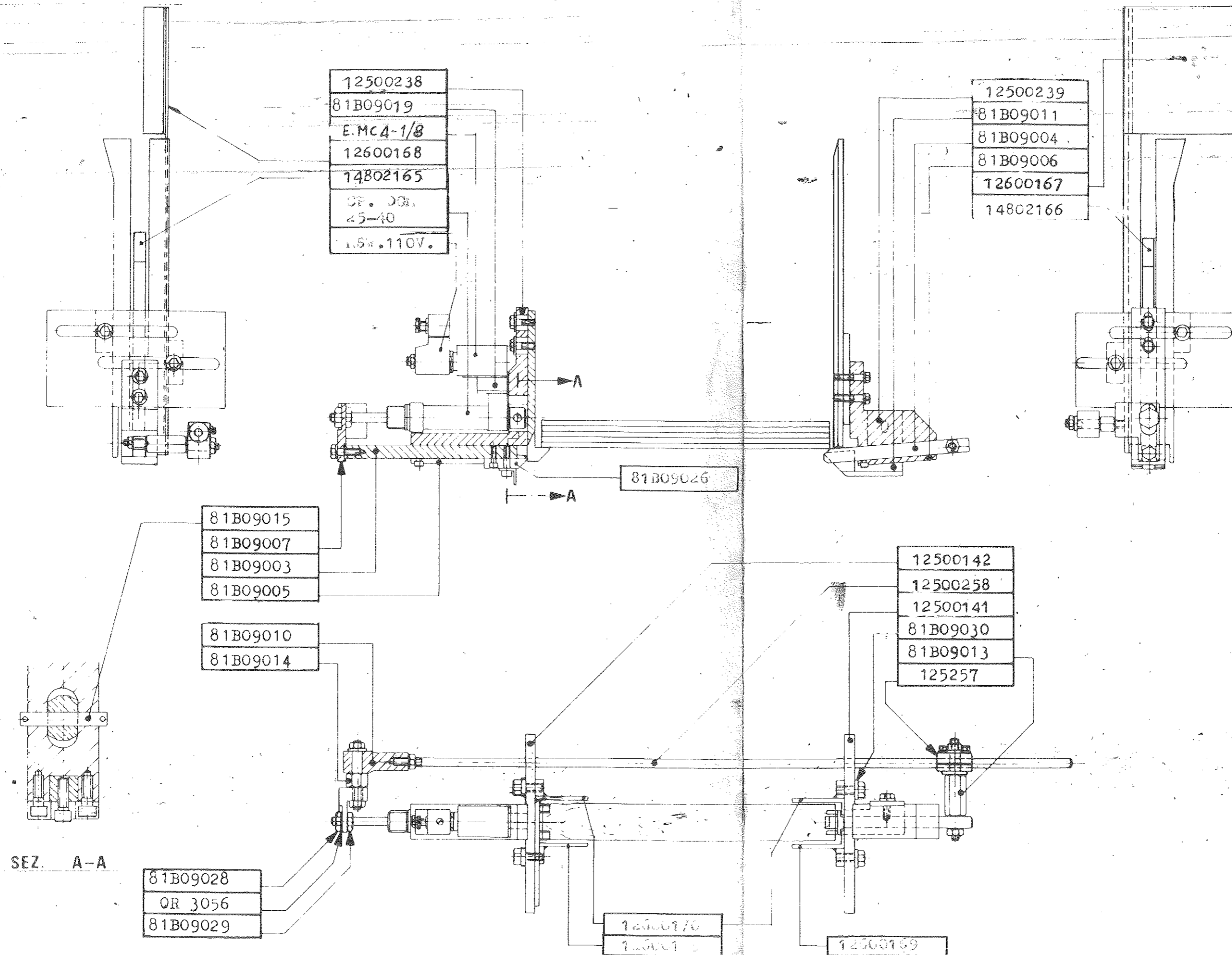



FRIZIONE ELETTRONAGNETICA

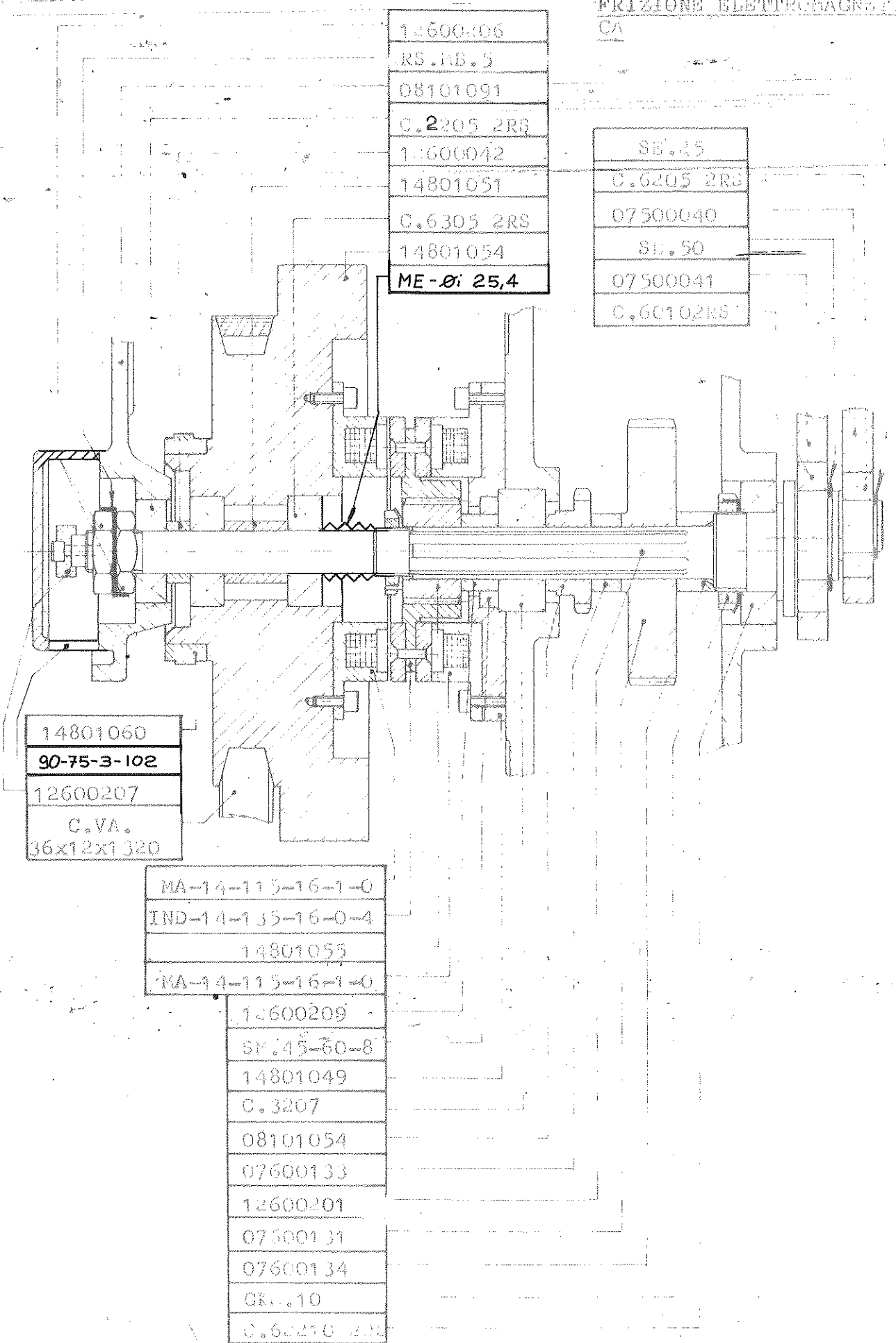

12600406
RS.MB.5
08101091
C.2205 2RS
12600042
14801051
C.6305 2RS
14801054
ME-Øi 25,4

SB.45
C.6205 2RS
07500040
SL.50
07500041
C.60102RS

14801060
90-75-3-102
12600207
C.VA.
36x12x1320

MA-14-115-16-1-0
IND-14-115-16-0-4
14801055
MA-14-115-16-1-0

12600209
SM.45-60-8
14801049
C.3207
08101054
07600133
12600201
07500131
07600134
GR.10
C.60210 2RS



FRIZIONE ELETTROMAGNETICA

